

PIN-BY-PIN GAMMA SCAN MEASUREMENT ON MOX AND UO₂ FUEL ASSEMBLIES AND EVALUATION

Stefan Misu and Herbert Spierling
Siemens AG, Power Generation (KWU), Erlangen (Germany)

Hoju Moon
Siemens Power Corporation, Richland, Washington

Anja Koschel
RWE-Energie AG, Essen (Germany)

ABSTRACT

A comprehensive pin-by-pin Gamma scan was carried out on one MOX fuel assembly and three UO₂ fuel assemblies at the Gundremmingen BWR. With the Gamma scanner suspended in the fuel pool, the La-140 and the Pr-144 activity was measured to determine relative rod-wise power and burnup, respectively. The scan was made during the optimal time period, four weeks after termination of the operating cycle, which allowed to determine especially the relative rod powers with high accuracy. All measured rods were scanned at four axial levels and selected rods were scanned at eight additional levels and continuously. This Gamma scan provides a valuable data base for the validation of BWR nuclear design codes with respect to local power and burnup distribution analysis. In the evaluation, analytical results of the BWR core simulator MICROBURN-B2 were compared with the measured data. The comparison demonstrates the high degree of accuracy of this reactor code. Measured and simulated axial power distributions for both MOX and UO₂ fuel assemblies agree very well. Calculated local power distributions in all fuel assemblies, including interface regions where rod power is strongly affected by MOX and UO₂ spectral interaction, are in very good agreement with the measured results.

1. INTRODUCTION

In the Spring of 1998 a comprehensive pin-by-pin Gamma scan was performed at the Gundremmingen BWR at the end of cycle (EOC) 13. The general purpose of these measurements was to generate a new data base for the validation of BWR nuclear design codes with respect to power distribution analysis. Accurate analysis of the axial, radial and local power density distribution is essential in optimizing the neutronic design of fuel assemblies which meet present and future fuel management requirements. The Gamma scan consisted of two parts:

First, fuel rods of one 9x9-1 MOX fuel assembly inserted at the beginning of cycle (BOC) 13 and two adjacent 9x9-1 UO₂ fuel assemblies loaded at BOC 12 and BOC 11, respectively, were scanned. This work was carried out under the international GERONIMO Program. The major goal of these measurements was to investigate the spectral effects between adjacent MOX and UO₂ fuel assemblies with respect to the pin-wise power distribution. These measurements and their evaluation will be emphasized here.

Second, rods of an ATRIUMTM10 UO₂ fuel assembly inserted at BOC 13 were scanned under a joint program of Siemens AG and its customer RWE-E, BAG/BKE and KGB. These measurements, which were aimed specifically at the validation of power distribution analysis for modern high-enrichment UO₂ fuel assemblies, were discussed in previous publications¹⁻³ already.

The Gamma scan, its evaluation with the Siemens BWR core simulator MICROBURN-B2, and the comparison of measured and calculated results are described below.

2. MEASUREMENTS ON 9X9-1 MOX AND UO₂ FUEL ASSEMBLIES

The Siemens underwater scanning device shown in Fig. 1 was used to perform the measurements subsequent to the March 1998 outage. The scanner consists mainly of a collimator setup featuring optimized shielding, with a fuel rod guide mechanism on one side and a high-purity Germanium detector, cooled with liquid Nitrogen, on the opposite side. The detector was connected to electronic equipment adapted to high count rates³. Standard spectroscopic software especially modified for this application was employed.

The scanning device was suspended from the operating floor into the fuel pool of the Gundremmingen B (GUN-B) BWR as shown schematically in Fig. 2. Using the plant's fuel reconstitution equipment, the fuel rods were removed from the fuel assembly and transferred to the scanning system. After having been pulled upward through the guide mechanism during the scan, they were reinserted into the fuel assembly.

The measurements were made during a period of 6 days, starting about 4 weeks after the termination of cycle 13. At this time, the radioactive decay of the nuclide La-140 is at equilibrium with the decay of the fission product Ba-140, and the Gamma line of La-140 at 1596 keV is clearly distinguishable from the decay of other nuclides. Thus, La-140 is suitable as a key nuclide for determining the fuel rod power distribution that existed in the reactor just before the shutdown. The key nuclide selected for determining fuel rod exposure is Pr-144, a daughter of Ce-144 which is a fission product with a half life of 284 days. Fig. 3 shows a typical example of a Gamma energy spectrum measured at the indicated elevation of a particular fuel rod of the MOX fuel assembly.

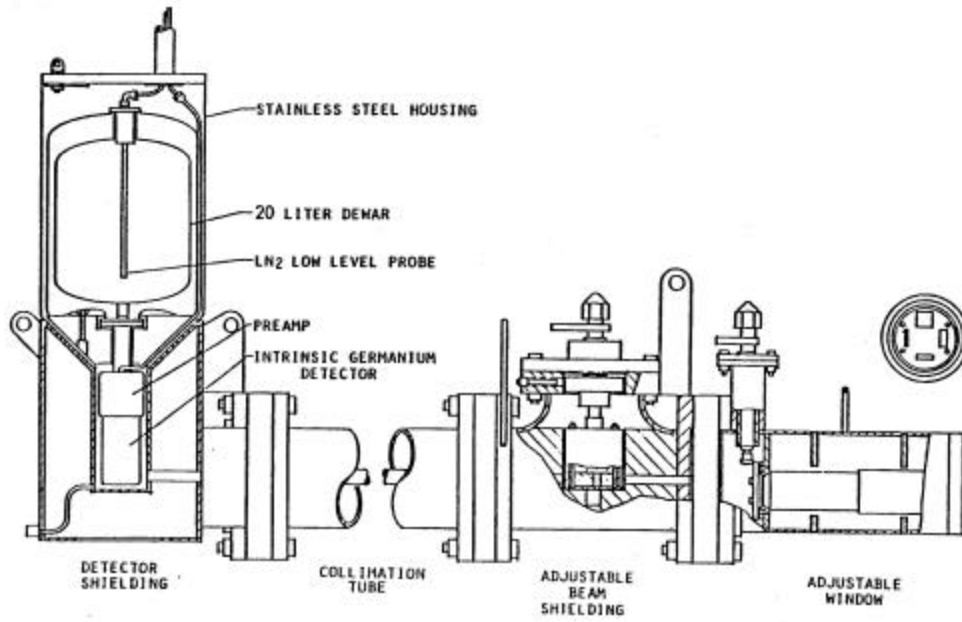

Figure 1: Underwater scanning device

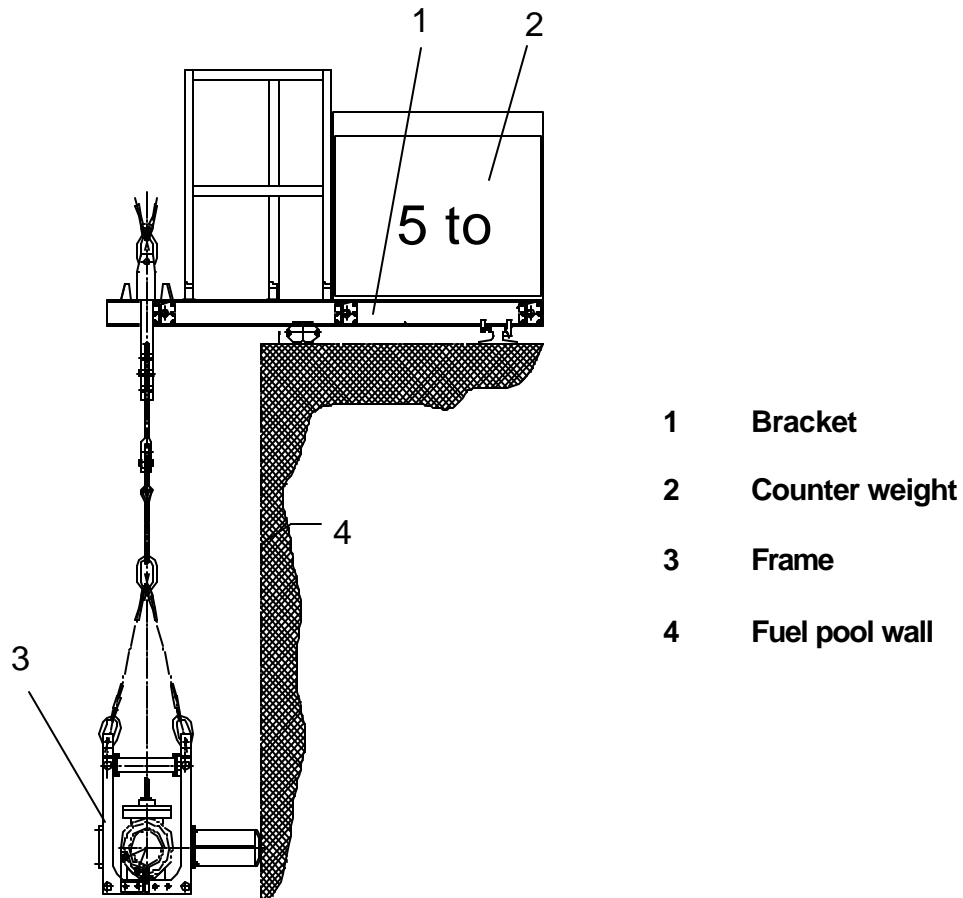

Figure 2: Scanning device suspended in the fuel pool

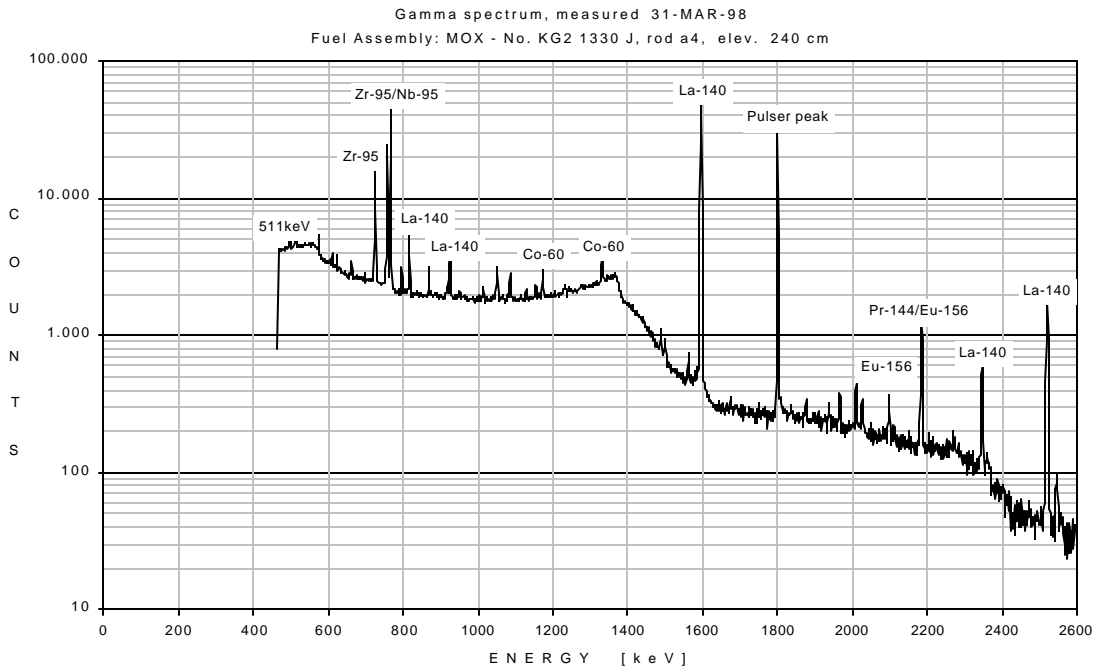
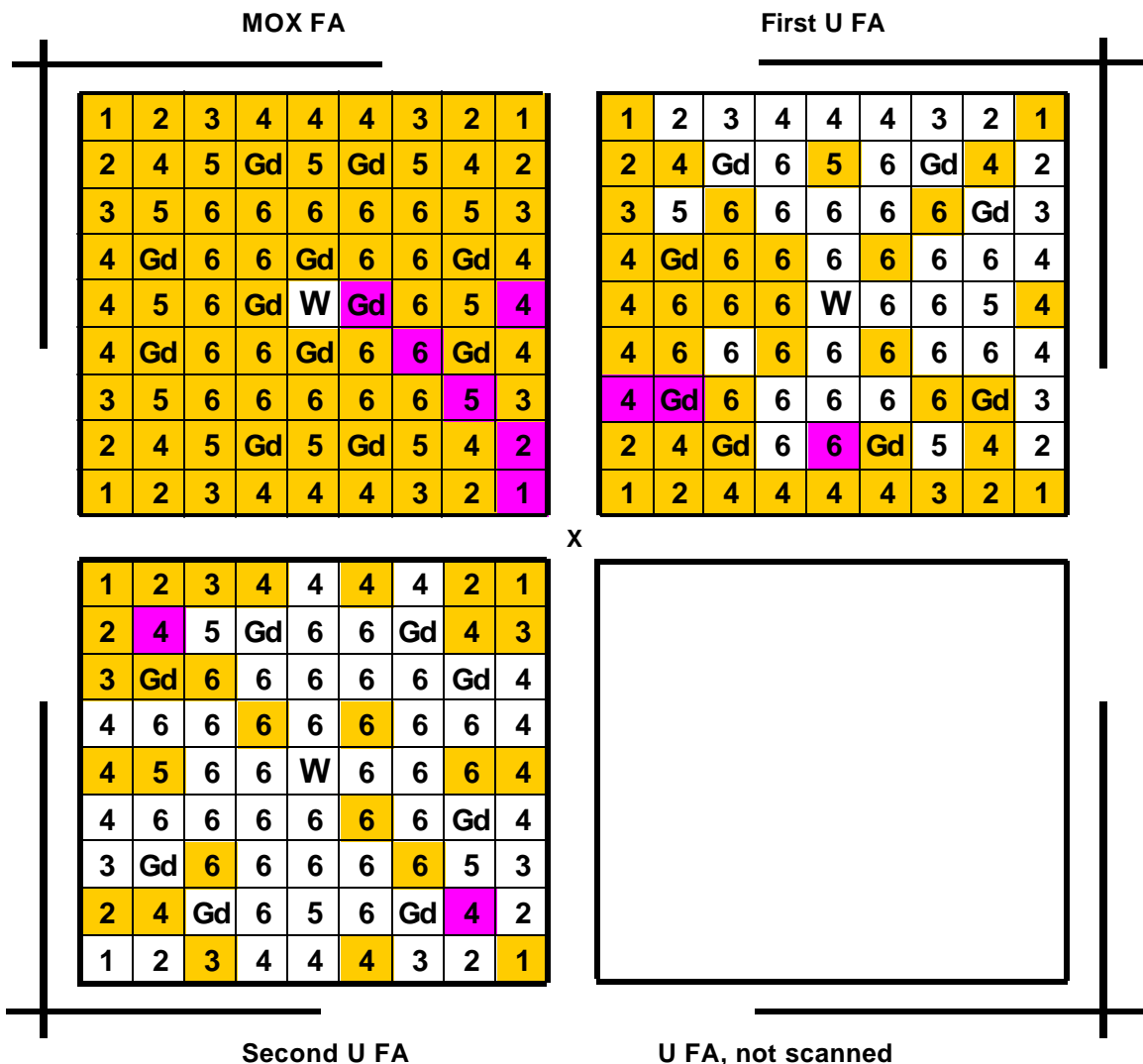

Figure 3: Example of a measured Gamma energy spectrum

GUN-B is a 1310 MWe BWR unit with 784 C lattice fuel assemblies. In the 13th cycle the core loading consisted mainly of 9x9-1 fuel assemblies. Sixty four of these were MOX fuel assemblies, half of which were in their first irradiation period. Seventy two fresh ATRIUMTM10 fuel assemblies had been inserted at BOC 13. The lattice configurations of the scanned 9x9-1 MOX and UO₂ fuel assemblies are shown in Fig. 4. Rods in the positions marked light gray were scanned at 4 elevations, rods in the dark gray positions were scanned at 12 axial levels and continuously. In either case, the levels scanned span the entire active length of the fuel, so that data is obtained for the total range of void fractions present in the core. All rods of the MOX assembly, about half the rods of the first adjacent UO₂ fuel assembly, and about one third of the rods in the second UO₂ fuel assembly were scanned. The rods to be scanned in the UO₂ assemblies were selected with a preference for positions close to the MOX assembly in order to be able to investigate in detail the spectral effects on rod power distribution. A total of 2100 spectra were taken while scanning 152 fuel rods from these three 9x9-1 assemblies.

Processing of the measured data is based on the net peak area of the relevant spectrum lines and the associated measurement time. The fission power density distribution is proportional to the Ba-140 distribution which is determined from the count rate measured for its daughter La-140. The measured values were back-calculated to the reference time (reactor shut down date). Dead-time corrections were made based on a pulser method.

The detailed appraisal of the experimental error, accounting for the effects of geometry, electronic processing, and counting statistics resulted in a total estimated measurement error of 0.5 % for the local pin power distribution and about 2 % for the local EOC rod exposure distribution.



Mox FA: 6 Pu concentration levels from 1.15 % (type 1) to 5.52 % (type 6) in tails U
Gd rods contain 1.25 % Gd in U fuel enriched to 3.95 % U-235

U FA: 6 U-235 enrichment levels, 1.70 % to 3.95 %, average enr. 3.14 % U-235

Fuel rod scanned at 4 axial levels

Fuel rod scanned at 12 axial levels and continuously

X Pseudo TIP position

Figure 4: Positions of the scanned rods in the three 9x9-1 fuel assemblies

3. EVALUATION

Results calculated with the Siemens 3D BWR core simulator MICROBURN-B2 were compared with the processed measured data. MICROBURN-B2 has advanced neutronic and thermal hydraulic models allowing for accurate simulation of BWR cores. A general flow diagram of the analytical steps carried out by MICROBURN-B2 is shown in Fig. 5.

Previous comprehensive validation work for many cycles of different BWRs has demonstrated a high level of accuracy in the prediction of reactivity and nodal power distributions⁴.

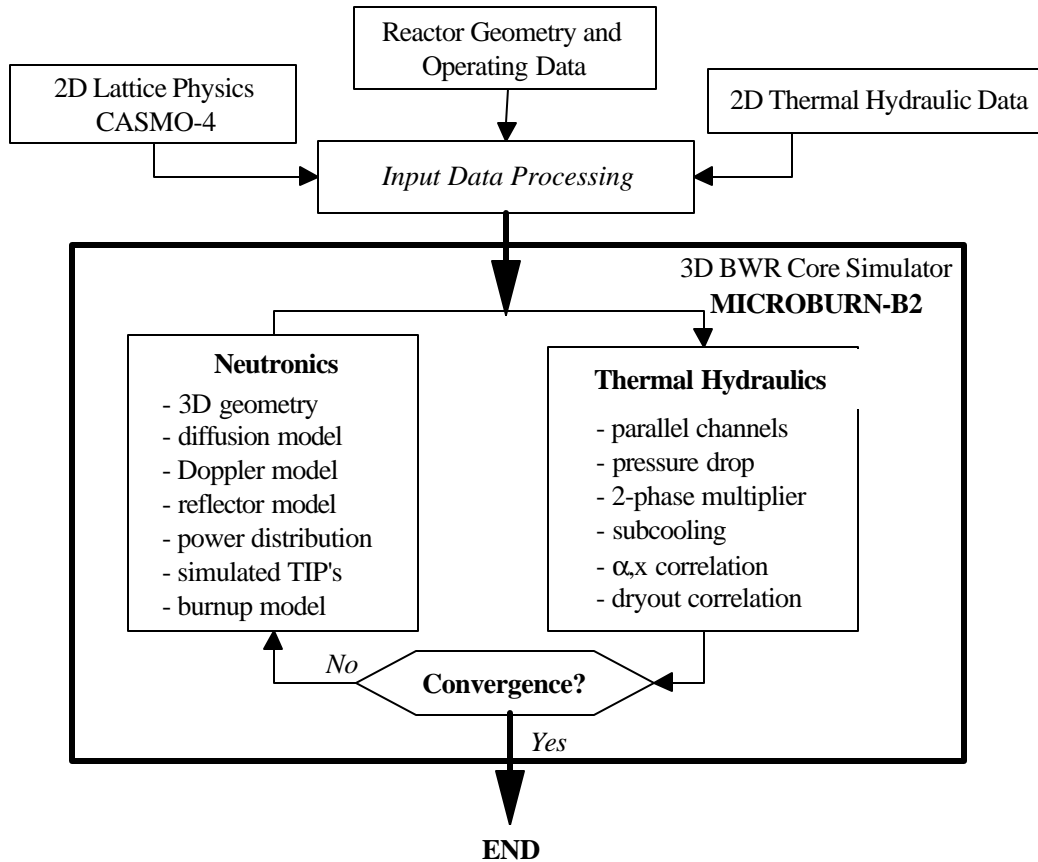

Figure 5: General flow diagram of MICROBURN-B2

Special emphasis has been given to the qualification of the reconstructed pin-by-pin power within the fuel assemblies, as they are directly related to safety parameters assuring fuel integrity. The high degree of accuracy of the pin-power reconstruction model in MICROBURN-B2 for the ATRIUM™ 10 fuel design was already shown in the previously published results for the ATRIUM™ 10 Gamma scan ^{1,2}. An analytical validation via four-bundle colorset comparisons with CASMO-3 and CASMO-4 /5/ multigroup transport calculations for UO₂/MOX configurations and an evaluation of the Quad Cities Gamma scan data ⁶ have confirmed the consistently high quality of the MICROBURN-B2 results. From all these tests it can be deduced that MICROBURN-B2 calculates local pin powers in the fuel assemblies with an uncertainty between 1%-2% for UO₂- and between 1.5%-2.6% for MOX fuel assemblies.

To predict the Ba-140 distribution for GUN-B EOC 13, the operating history from cycle 1 of this reactor was tracked with MICROBURN-B2 using lattice neutronic data generated with CASMO-4 and thermal hydraulic data generated with Siemens standard procedures. The core tracking results were found to stay well within the tight uncertainty bound of MICROBURN-B2, indicating that reactivity and nodal powers are calculated with good accuracy. The axial and radial pin power distributions calculated with MICROBURN-B2 for EOC 13 were used in conjunction with pin power data from CASMO-4 to generate simulated Ba-140 distributions for the scanned UO₂ and MOX fuel assemblies.

4. RESULTS

Ratios of measured and simulated Ba-140 distributions are given for the MOX fuel assembly in Fig. 6. The scan level 39 cm above the bottom of the core is used as an example.

The deviations from unity for individual pins are well distributed within the bundle grid with no obvious trend. Neither at the position of the maximum power (g-8) nor for Gadolinium pins (example: e-4, which was near the central water pin, or g-6 surrounded only by fuel pins) do larger differences occur. This also applies to the peripheral fuel rods in row k and column 9, where spectrum differences between MOX and UO₂ fuel most strongly affect pin powers. Similar conclusions can be drawn from the investigation of fuel rod powers in other scan levels of the MOX fuel assembly and for the UO₂ fuel assemblies as well. The results obtained with MICROBURN-B2 are remarkably good if one takes into account the fact that the 9x9-1 UO₂ and MOX fuel assemblies were placed in the vicinity of the reflector (4th and 5th fuel assembly row counted from the core periphery) and thus were subject to strong global gradients. Furthermore, the Gadolinium in the MOX fuel assembly (fresh at BOC 13) was not yet burned out and significantly reduced the power of the Gd pins. Nevertheless, the MOX fuel assembly (as well as the scanned ATRIUMTM10 fuel assembly) had reached, at the end of the first irradiation period, the highest relative power of the insertion history. A code validation carried out for this condition appears particularly valuable.

IJ	1	2	3	4	5	6	7	8	9
k	0.989	0.983	1.035	1.004	0.977	0.977	1.050	0.981	0.983
h	1.008	0.986	1.028	0.984	0.981	0.987	1.016	0.964	0.993
g	1.044	1.013	0.989	1.013	0.982	0.990	0.984	1.025	0.998
f	0.974	1.000	1.021	0.986	0.974	0.980	0.980	0.988	0.989
e	0.987	0.993	1.002	1.007	WWW	0.990	0.982	0.973	0.998
d	1.035	0.997	1.018	1.022	0.999	0.991	0.977	0.982	0.974
c	1.005	1.028	1.006	1.030	0.992	1.019	0.982	1.011	1.013
b	1.013	1.029	0.989	0.995	0.988	0.987	0.986	0.977	0.965
a	1.002	1.017	1.015	0.987	1.041	1.026	1.044	1.038	1.034

Figure 6: Ratio of measured to simulated Ba-140 distribution at axial level 39 cm for all measured pins of the MOX 9x9-1 fuel assembly.

For both of the measured 9x9-1 UO₂ bundles the statistical deviation (root-mean-square) of the pin power distributions in the measured planes range from 1.6 % to 2.7 % with an overall value of 2.1 %. For the measured MOX fuel assembly, the deviations range from 2.0 to 3.6 %, with a fuel assembly overall uncertainty of 3.1 %. Fig. 7 shows, for the MOX fuel assembly and the UO₂ fuel assemblies, the frequency distribution of rod-wise local power deviations in all planes of measurement.

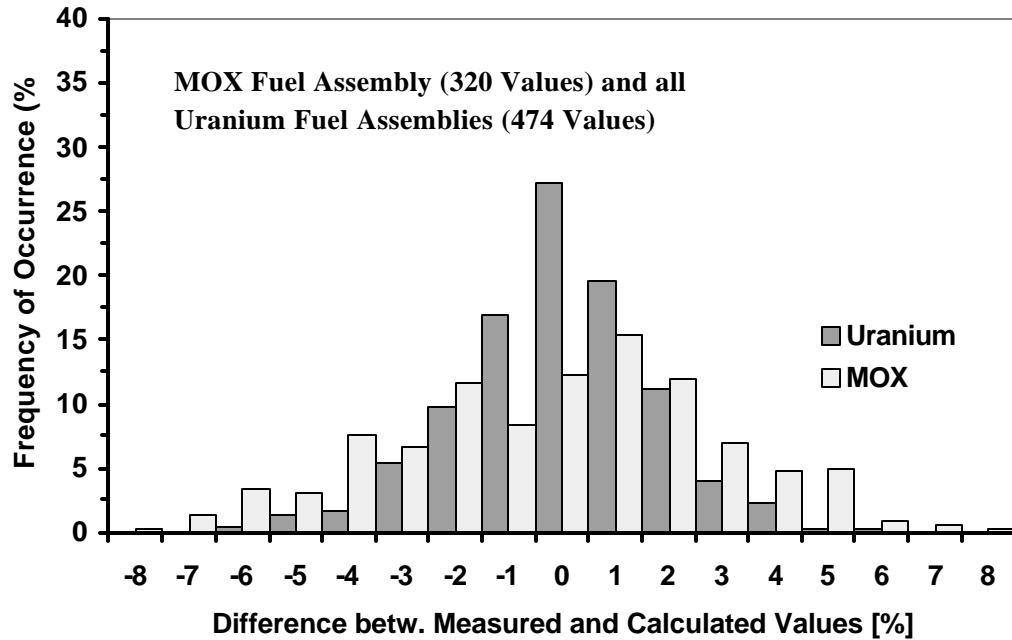

Figure 7: Frequency distribution of all local deviations (ratio of measured and calculated Ba distributions) for MOX and U fuel assemblies.

In Fig. 8 the comparison of measured and simulated values for continuously measured pins is exemplified by a MOX fuel rod with high Pu concentration. The calculated values fit the measured ones very well. Similar results were obtained for other continuously measured rods of the MOX fuel assembly and the UO₂ fuel assemblies.

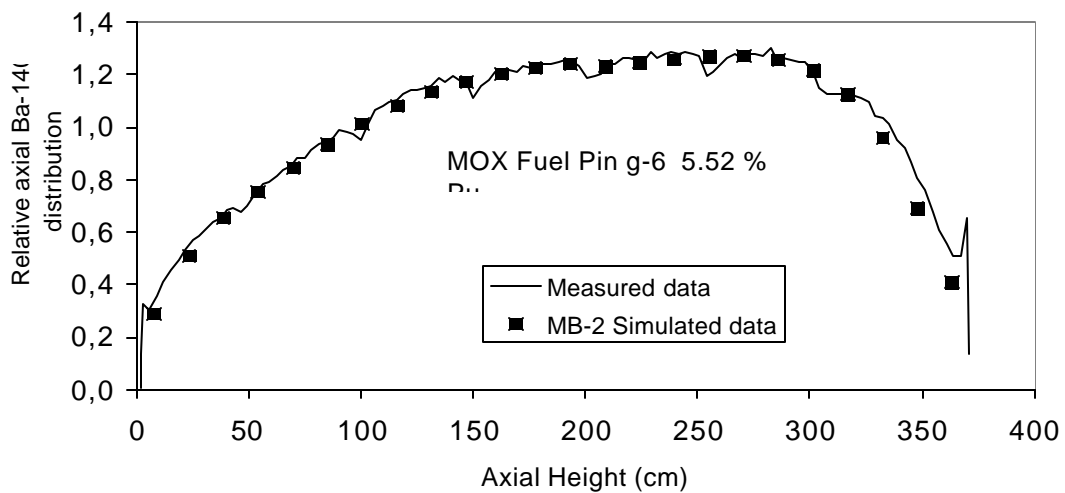

Figure 8: Comparison of measured and calculated Ba-140 distributions for a continuously measured pin of the MOX fuel assembly.

From all comparisons of measured and calculated Ba-140 distributions there is no indication of a systematic dependence of the quality of the results on void fraction in the core during power operation. Systematic errors related to the type of adjacent fuel assembly (MOX or UO₂) are not observed.

5. CONCLUSIONS

The Gamma scan of one MOX and three UO₂ (including one ATRIUMTM10) fuel assemblies at the Boiling Water Reactor GUN-B produced a highly accurate measurement of pin power distributions, thus providing an excellent data base for BWR core physics method qualification. This data was used to qualify the pin power reconstruction model of the Siemens BWR Simulator MICROBURN-B2 for UO₂ /MOX core design. The comparison of measured and calculated Ba-140 distributions for both the scan at selected axial levels and the continuous axial scan demonstrates the high degree of accuracy of the core simulator.

ACKNOWLEDGEMENTS

The GERONIMO Program is coordinated by BELGONUCLEAIRE; participants are Siemens/KWU, RWE-E, BAG/BKE, SCK.CEN, COGEMA, NFI, HITACHI, TOSHIBA, Tokyo Electric Power Company, Tohoku Electric Power Company, Chubu Electric Power Co., Hokuriku Electric Power Company, The Chugoku Electric Power Co, and The Japan Atomic Power Company.

REFERENCES

1. H. Spierling, St. Misu, H. Moon, "Fuel Rod Gamma Scan of a Siemens ATRIUM-10 Fuel Assembly", ANS Transactions Vol. 80, pp. 261-263 (1999).
2. St. Misu, W. Timm, A. Koschel, "Qualification of the Pin Power Reconstruction Model in MICROBURN-B2 Based on the Measured ATRIUMTM10 Pin-by-Pin Gamma-Scan in GUN-B", JK 1999.
3. R. Hoffmann, K. Knecht, H. Spierling, F. Seibold, "Durchführung eines stabweisen Gamma-Scans an einem ATRIUMTM10 – Brennelement in Gundremmingen", JK 1999
4. St. Misu, H. Moon, "The SIEMENS 3-D Steady State BWR Core Simulator MICROBURN-B2", Proc. Int. Conf. Nucl. Sci. and Tech., Vol 2, p. 1097, Long Island NY, Oct.1998.
5. M. Edenius, B. H. Forssen and C. Gragg, "The Physics Model of CASMO-4", Proc. Adv. in Math., Com., & Reactor Physics, Vol. 10-1, Pittsburg (1991).
6. "Gamma Scan Measurements at Quad Cities Nuclear Power Station Unit 1 Following Cycle 2", EPRI-NP-214 (July 1976).